

Network Working Group
Request for Comments: 3948
Category: Standards Track

A. Huttunen
F-Secure Corporation
B. Swander
Microsoft
V. Volpe
Cisco Systems
L. DiBurro
Nortel Networks
M. Stenberg
January 2005

UDP Encapsulation of IPsec ESP Packets

Status of this Memo

This document specifies an Internet standards track protocol for the Internet community, and requests discussion and suggestions for improvements. Please refer to the current edition of the "Internet Official Protocol Standards" (STD 1) for the standardization state and status of this protocol. Distribution of this memo is unlimited.

Copyright Notice

Copyright (C) The Internet Society (2005).

Abstract

This protocol specification defines methods to encapsulate and decapsulate IP Encapsulating Security Payload (ESP) packets inside UDP packets for traversing Network Address Translators. ESP encapsulation, as defined in this document, can be used in both IPv4 and IPv6 scenarios. Whenever negotiated, encapsulation is used with Internet Key Exchange (IKE).

Table of Contents

1.	Introduction	2
2.	Packet Formats	3
2.1.	UDP-Encapsulated ESP Header Format	3
2.2.	IKE Header Format for Port 4500	4
2.3.	NAT-Keepalive Packet Format	4
3.	Encapsulation and Decapsulation Procedures	5
3.1.	Auxiliary Procedures	5
3.1.1.	Tunnel Mode Decapsulation NAT Procedure	5
3.1.2.	Transport Mode Decapsulation NAT Procedure	5
3.2.	Transport Mode ESP Encapsulation	6
3.3.	Transport Mode ESP Decapsulation	6
3.4.	Tunnel Mode ESP Encapsulation	7
3.5.	Tunnel Mode ESP Decapsulation	7
4.	NAT Keepalive Procedure	7
5.	Security Considerations	8
5.1.	Tunnel Mode Conflict	8
5.2.	Transport Mode Conflict	9
6.	IAB Considerations	10
7.	Acknowledgments	11
8.	References	11
8.1.	Normative References	11
8.2.	Informative References	11
A.	Clarification of Potential NAT Multiple Client Solutions	12
	Authors' Addresses	14
	Full Copyright Statement	15

1. Introduction

This protocol specification defines methods to encapsulate and decapsulate ESP packets inside UDP packets for traversing Network Address Translators (NATs) (see [RFC3715], section 2.2, case i). The UDP port numbers are the same as those used by IKE traffic, as defined in [RFC3947].

The sharing of the port numbers for both IKE and UDP encapsulated ESP traffic was selected because it offers better scaling (only one NAT mapping in the NAT; no need to send separate IKE keepalives), easier configuration (only one port to be configured in firewalls), and easier implementation.

A client's needs should determine whether transport mode or tunnel mode is to be supported (see [RFC3715], Section 3, "Telecommuter scenario"). L2TP/IPsec clients MUST support the modes as defined in [RFC3193]. IPsec tunnel mode clients MUST support tunnel mode.

An IKE implementation supporting this protocol specification MUST NOT use the ESP SPI field zero for ESP packets. This ensures that IKE packets and ESP packets can be distinguished from each other.

As defined in this document, UDP encapsulation of ESP packets is written in terms of IPv4 headers. There is no technical reason why an IPv6 header could not be used as the outer header and/or as the inner header.

Because the protection of the outer IP addresses in IPsec AH is inherently incompatible with NAT, the IPsec AH was left out of the scope of this protocol specification. This protocol also assumes that IKE (IKEv1 [RFC2401] or IKEv2 [IKEv2]) is used to negotiate the IPsec SAs. Manual keying is not supported.

The key words "MUST", "MUST NOT", "REQUIRED", "SHALL", "SHALL NOT", "SHOULD", "SHOULD NOT", "RECOMMENDED", "MAY", and "OPTIONAL" in this document are to be interpreted as described in [RFC2119].

2. Packet Formats

2.1. UDP-Encapsulated ESP Header Format

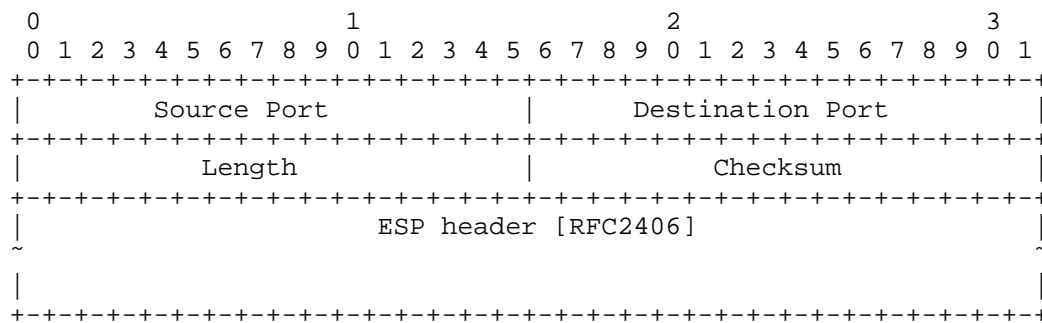

The UDP header is a standard [RFC0768] header, where

- o the Source Port and Destination Port MUST be the same as that used by IKE traffic,
- o the IPv4 UDP Checksum SHOULD be transmitted as a zero value, and
- o receivers MUST NOT depend on the UDP checksum being a zero value.

The SPI field in the ESP header MUST NOT be a zero value.

2.2. IKE Header Format for Port 4500

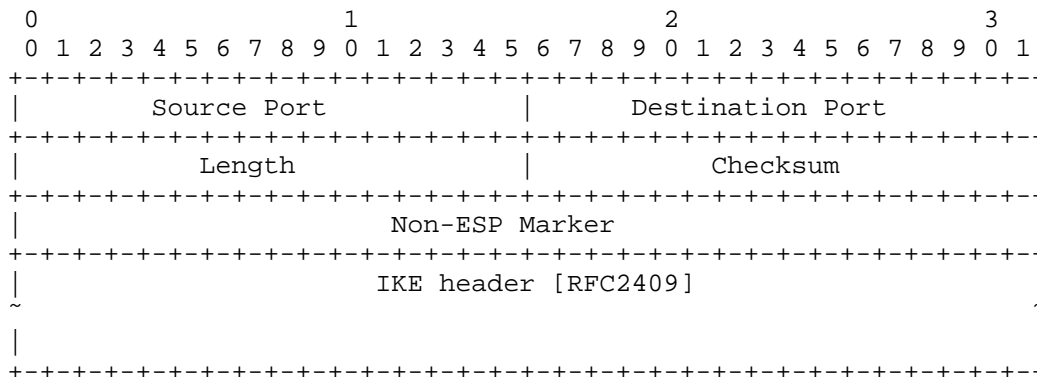

The UDP header is a standard [RFC0768] header and is used as defined in [RFC3947]. This document does not set any new requirements for the checksum handling of an IKE packet.

A Non-ESP Marker is 4 zero-valued bytes aligning with the SPI field of an ESP packet.

2.3. NAT-Keepalive Packet Format

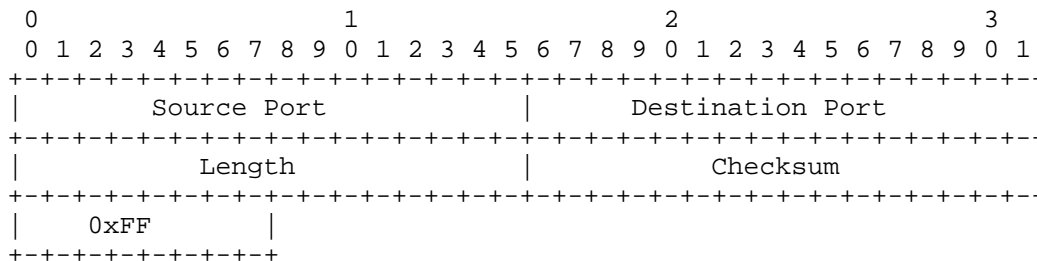

The UDP header is a standard [RFC0768] header, where

- o the Source Port and Destination Port MUST be the same as used by UDP-ESP encapsulation of Section 2.1,
- o the IPv4 UDP Checksum SHOULD be transmitted as a zero value, and
- o receivers MUST NOT depend upon the UDP checksum being a zero value.

The sender MUST use a one-octet-long payload with the value 0xFF. The receiver SHOULD ignore a received NAT-keepalive packet.

3. Encapsulation and Decapsulation Procedures

3.1. Auxiliary Procedures

3.1.1. Tunnel Mode Decapsulation NAT Procedure

When a tunnel mode has been used to transmit packets (see [RFC3715], section 3, criteria "Mode support" and "Telecommuter scenario"), the inner IP header can contain addresses that are not suitable for the current network. This procedure defines how these addresses are to be converted to suitable addresses for the current network.

Depending on local policy, one of the following MUST be done:

1. If a valid source IP address space has been defined in the policy for the encapsulated packets from the peer, check that the source IP address of the inner packet is valid according to the policy.
2. If an address has been assigned for the remote peer, check that the source IP address used in the inner packet is the assigned IP address.
3. NAT is performed for the packet, making it suitable for transport in the local network.

3.1.2. Transport Mode Decapsulation NAT Procedure

When a transport mode has been used to transmit packets, contained TCP or UDP headers will have incorrect checksums due to the change of parts of the IP header during transit. This procedure defines how to fix these checksums (see [RFC3715], section 2.1, case b).

Depending on local policy, one of the following MUST be done:

1. If the protocol header after the ESP header is a TCP/UDP header and the peer's real source and destination IP address have been received according to [RFC3947], incrementally recompute the TCP/UDP checksum:
 - * Subtract the IP source address in the received packet from the checksum.
 - * Add the real IP source address received via IKE to the checksum (obtained from the NAT-OA)
 - * Subtract the IP destination address in the received packet from the checksum.
 - * Add the real IP destination address received via IKE to the checksum (obtained from the NAT-OA).

Note: If the received and real address are the same for a given address (e.g., say the source address), the operations cancel and don't need to be performed.

2. If the protocol header after the ESP header is a TCP/UDP header, recompute the checksum field in the TCP/UDP header.
3. If the protocol header after the ESP header is a UDP header, set the checksum field to zero in the UDP header. If the protocol after the ESP header is a TCP header, and if there is an option to flag to the stack that the TCP checksum does not need to be computed, then that flag MAY be used. This SHOULD only be done for transport mode, and if the packet is integrity protected. Tunnel mode TCP checksums MUST be verified. (This is not a violation to the spirit of section 4.2.2.7 in [RFC1122] because a checksum is being generated by the sender and verified by the receiver. That checksum is the integrity over the packet performed by IPsec.)

In addition an implementation MAY fix any contained protocols that have been broken by NAT (see [RFC3715], section 2.1, case g).

3.2. Transport Mode ESP Encapsulation

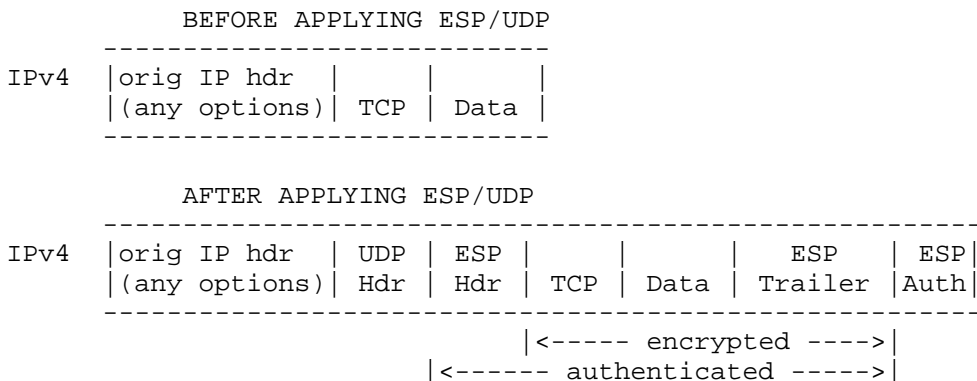

1. Ordinary ESP encapsulation procedure is used.
2. A properly formatted UDP header is inserted where shown.
3. The Total Length, Protocol, and Header Checksum (for IPv4) fields in the IP header are edited to match the resulting IP packet.

3.3. Transport Mode ESP Decapsulation

1. The UDP header is removed from the packet.
2. The Total Length, Protocol, and Header Checksum (for IPv4) fields in the new IP header are edited to match the resulting IP packet.
3. Ordinary ESP decapsulation procedure is used.
4. Transport mode decapsulation NAT procedure is used.

3.4. Tunnel Mode ESP Encapsulation

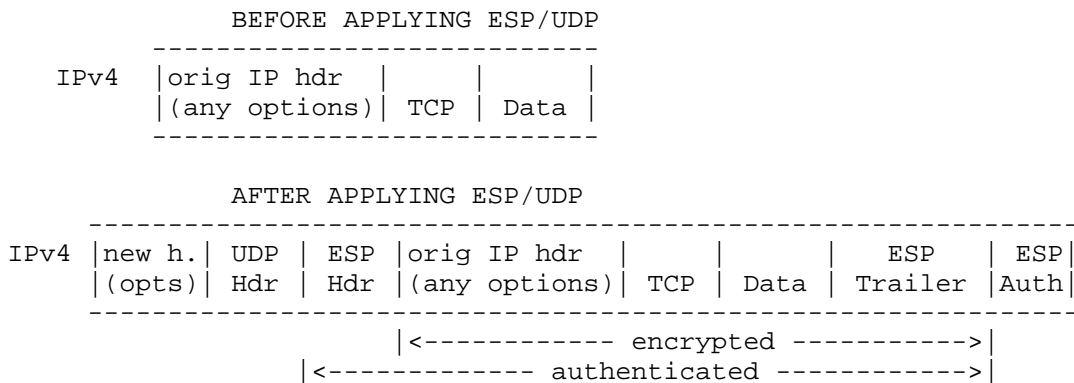

1. Ordinary ESP encapsulation procedure is used.
2. A properly formatted UDP header is inserted where shown.
3. The Total Length, Protocol, and Header Checksum (for IPv4) fields in the new IP header are edited to match the resulting IP packet.

3.5. Tunnel Mode ESP Decapsulation

1. The UDP header is removed from the packet.
2. The Total Length, Protocol, and Header Checksum (for IPv4) fields in the new IP header are edited to match the resulting IP packet.
3. Ordinary ESP decapsulation procedure is used.
4. Tunnel mode decapsulation NAT procedure is used.

4. NAT Keepalive Procedure

The sole purpose of sending NAT-keepalive packets is to keep NAT mappings alive for the duration of a connection between the peers (see [RFC3715], Section 2.2, case j). Reception of NAT-keepalive packets MUST NOT be used to detect whether a connection is live.

A peer MAY send a NAT-keepalive packet if one or more phase I or phase II SAs exist between the peers, or if such an SA has existed at most N minutes earlier. N is a locally configurable parameter with a default value of 5 minutes.

A peer SHOULD send a NAT-keepalive packet if a need for it is detected according to [RFC3947] and if no other packet to the peer has been sent in M seconds. M is a locally configurable parameter with a default value of 20 seconds.

5. Security Considerations

5.1. Tunnel Mode Conflict

Implementors are warned that it is possible for remote peers to negotiate entries that overlap in an SGW (security gateway), an issue affecting tunnel mode (see [RFC3715], section 2.1, case e).

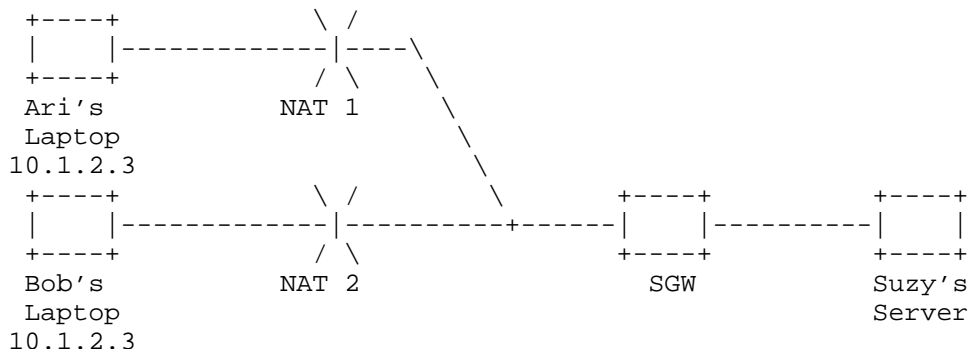

Because SGW will now see two possible SAs that lead to 10.1.2.3, it can become confused about where to send packets coming from Suzy's server. Implementors MUST devise ways of preventing this from occurring.

It is RECOMMENDED that SGW either assign locally unique IP addresses to Ari's and Bob's laptop (by using a protocol such as DHCP over IPsec) or use NAT to change Ari's and Bob's laptop source IP addresses to these locally unique addresses before sending packets forward to Suzy's server. This covers the "Scaling" criteria of section 3 in [RFC3715].

Please see Appendix A.

5.2. Transport Mode Conflict

Another similar issue may occur in transport mode, with 2 clients, Ari and Bob, behind the same NAT talking securely to the same server (see [RFC3715], Section 2.1, case e).

Cliff wants to talk in the clear to the same server.

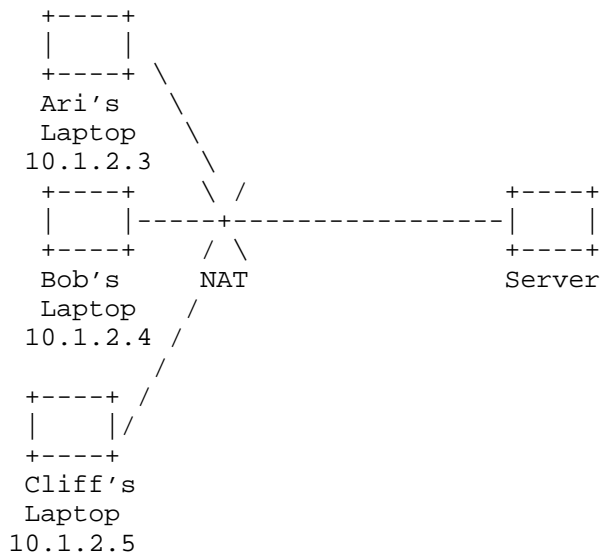

Now, transport SAs on the server will look like this:

To Ari: Server to NAT, <traffic desc1>, UDP encap <4500, Y>

To Bob: Server to NAT, <traffic desc2>, UDP encap <4500, Z>

Cliff's traffic is in the clear, so there is no SA.

<traffic desc> is the protocol and port information. The UDP encap ports are the ports used in UDP-encapsulated ESP format of section 2.1. Y,Z are the dynamic ports assigned by the NAT during the IKE negotiation. So IKE traffic from Ari's laptop goes out on UDP <4500,4500>. It reaches the server as UDP <Y,4500>, where Y is the dynamically assigned port.

If the <traffic desc1> overlaps <traffic desc2>, then simple filter lookups may not be sufficient to determine which SA has to be used to send traffic. Implementations MUST handle this situation, either by disallowing conflicting connections, or by other means.

Assume now that Cliff wants to connect to the server in the clear. This is going to be difficult to configure, as the server already has a policy (from Server to the NAT's external address) for securing <traffic desc>. For totally non-overlapping traffic descriptions, this is possible.

Sample server policy could be as follows:

To Ari: Server to NAT, All UDP, secure

To Bob: Server to NAT, All TCP, secure

To Cliff: Server to NAT, ALL ICMP, clear text

Note that this policy also lets Ari and Bob send cleartext ICMP to the server.

The server sees all clients behind the NAT as the same IP address, so setting up different policies for the same traffic descriptor is in principle impossible.

A problematic example of configuration on the server is as follows:

Server to NAT, TCP, secure (for Ari and Bob)

Server to NAT, TCP, clear (for Cliff)

The server cannot enforce his policy, as it is possible that misbehaving Bob sends traffic in the clear. This is indistinguishable from when Cliff sends traffic in the clear. So it is impossible to guarantee security from some clients behind a NAT, while allowing clear text from different clients behind the SAME NAT. If the server's security policy allows this, however, it can do best-effort security: If the client from behind the NAT initiates security, his connection will be secured. If he sends in the clear, the server will still accept that clear text.

For security guarantees, the above problematic scenario MUST NOT be allowed on servers. For best effort security, this scenario MAY be used.

Please see Appendix A.

6. IAB Considerations

The UNSAF [RFC3424] questions are addressed by the IPsec-NAT compatibility requirements document [RFC3715].

7. Acknowledgments

Thanks to Tero Kivinen and William Dixon, who contributed actively to this document.

Thanks to Joern Sierwald, Tamir Zegman, Tatu Ylonen, and Santeri Paavolainen, who contributed to the early documents about NAT traversal.

8. References

8.1. Normative References

- [RFC0768] Postel, J., "User Datagram Protocol", STD 6, RFC 768, August 1980.
- [RFC2119] Bradner, S., "Key words for use in RFCs to Indicate Requirement Levels", BCP 14, RFC 2119, March 1997.
- [RFC2401] Kent, S. and R. Atkinson, "Security Architecture for the Internet Protocol", RFC 2401, November 1998.
- [RFC2406] Kent, S. and R. Atkinson, "IP Encapsulating Security Payload (ESP)", RFC 2406, November 1998.
- [RFC2409] Harkins, D. and D. Carrel, "The Internet Key Exchange (IKE)", RFC 2409, November 1998.
- [RFC3947] Kivinen, T., "Negotiation of NAT-Traversal in the IKE", RFC 3947, January 2005.

8.2. Informative References

- [RFC1122] Braden, R., "Requirements for Internet Hosts - Communication Layers", STD 3, RFC 1122, October 1989.
- [RFC3193] Patel, B., Aboba, B., Dixon, W., Zorn, G., and S. Booth, "Securing L2TP using IPsec", RFC 3193, November 2001.
- [RFC3424] Daigle, L. and IAB, "IAB Considerations for UNilateral Self-Address Fixing (UNSAF) Across Network Address Translation", RFC 3424, November 2002.
- [RFC3715] Aboba, B. and W. Dixon, "IPsec-Network Address Translation (NAT) Compatibility Requirements", RFC 3715, March 2004.
- [IKEv2] Kaufman, C., "Internet Key Exchange (IKEv2) Protocol", Work in Progress, October 2004.

Appendix A. Clarification of Potential NAT Multiple Client Solutions

This appendix provides clarification about potential solutions to the problem of multiple clients behind the same NAT simultaneously connecting to the same destination IP address.

Sections 5.1 and 5.2 say that you MUST avoid this problem. As this is not a matter of wire protocol, but a matter local implementation, the mechanisms do not belong in the protocol specification itself. They are instead listed in this appendix.

Choosing an option will likely depend on the scenarios for which one uses/supports IPsec NAT-T. This list is not meant to be exhaustive, so other solutions may exist. We first describe the generic choices that solve the problem for all upper-layer protocols.

Generic choices for ESP transport mode:

Tr1) Implement a built-in NAT (network address translation) above IPsec decapsulation.

Tr2) Implement a built-in NAT (network address port translation) above IPsec decapsulation.

Tr3) An initiator may decide not to request transport mode once NAT is detected and may instead request a tunnel-mode SA. This may be a retry after transport mode is denied by the responder, or the initiator may choose to propose a tunnel SA initially. This is no more difficult than knowing whether to propose transport mode or tunnel mode without NAT. If for some reason the responder prefers or requires tunnel mode for NAT traversal, it must reject the quick mode SA proposal for transport mode.

Generic choices for ESP tunnel mode:

Tn1) Same as Tr1.

Tn2) Same as Tr2.

Tn3) This option is possible if an initiator can be assigned an address through its tunnel SA, with the responder using DHCP. The initiator may initially request an internal address via the DHCP-IPsec method, regardless of whether it knows it is behind a NAT. It may re-initiate an IKE quick mode negotiation for DHCP tunnel SA after the responder fails the quick mode SA transport mode proposal. This happens either when a NAT-OA payload is sent or because it

discovers from NAT-D that the initiator is behind a NAT and its local configuration/policy will only accept a NAT connection when being assigned an address through DHCP-IPsec.

There are also implementation choices that offer limited interoperability. Implementors should specify which applications or protocols should work if these options are selected. Note that neither Tr4 nor Tn4, as described below, are expected to work with TCP traffic.

Limited interoperability choices for ESP transport mode:

Tr4) Implement upper-layer protocol awareness of the inbound and outbound IPsec SA so that it doesn't use the source IP and the source port as the session identifier (e.g., an L2TP session ID mapped to the IPsec SA pair that doesn't use the UDP source port or the source IP address for peer uniqueness).

Tr5) Implement application integration with IKE initiation so that it can rebind to a different source port if the IKE quick mode SA proposal is rejected by the responder; then it can repropose the new QM selector.

Limited interoperability choices for ESP tunnel mode:

Tn4) Same as Tr4.

Authors' Addresses

Ari Huttunen
F-Secure Corporation
Tammasaarencatu 7
HELSINKI FIN-00181
FI

EEmail: Ari.Huttunen@F-Secure.com

Brian Swander
Microsoft
One Microsoft Way
Redmond, WA 98052
US

EEmail: briansw@microsoft.com

Victor Volpe
Cisco Systems
124 Grove Street
Suite 205
Franklin, MA 02038
US

EEmail: vvolpe@cisco.com

Larry DiBurro
Nortel Networks
80 Central Street
Boxborough, MA 01719
US

EEmail: ldiburro@nortelnetworks.com

Markus Stenberg
FI

EEmail: markus.stenberg@iki.fi

Full Copyright Statement

Copyright (C) The Internet Society (2005).

This document is subject to the rights, licenses and restrictions contained in BCP 78, and except as set forth therein, the authors retain all their rights.

This document and the information contained herein are provided on an "AS IS" basis and THE CONTRIBUTOR, THE ORGANIZATION HE/SHE REPRESENTS OR IS SPONSORED BY (IF ANY), THE INTERNET SOCIETY AND THE INTERNET ENGINEERING TASK FORCE DISCLAIM ALL WARRANTIES, EXPRESS OR IMPLIED, INCLUDING BUT NOT LIMITED TO ANY WARRANTY THAT THE USE OF THE INFORMATION HEREIN WILL NOT INFRINGE ANY RIGHTS OR ANY IMPLIED WARRANTIES OF MERCHANTABILITY OR FITNESS FOR A PARTICULAR PURPOSE.

Intellectual Property

The IETF takes no position regarding the validity or scope of any Intellectual Property Rights or other rights that might be claimed to pertain to the implementation or use of the technology described in this document or the extent to which any license under such rights might or might not be available; nor does it represent that it has made any independent effort to identify any such rights. Information on the IETF's procedures with respect to rights in IETF Documents can be found in BCP 78 and BCP 79.

Copies of IPR disclosures made to the IETF Secretariat and any assurances of licenses to be made available, or the result of an attempt made to obtain a general license or permission for the use of such proprietary rights by implementers or users of this specification can be obtained from the IETF on-line IPR repository at <http://www.ietf.org/ipr>.

The IETF invites any interested party to bring to its attention any copyrights, patents or patent applications, or other proprietary rights that may cover technology that may be required to implement this standard. Please address the information to the IETF at ietf-ipr@ietf.org.

Acknowledgement

Funding for the RFC Editor function is currently provided by the Internet Society.